



# Vinyl Windows

## Series 700 Windows, Single Hung Tilt

### Standard Features

- Constructed with white virgin PVC vinyl
- 2-3/8" overall frame dimension: 1" face to fin; lap pocket for vinyl siding
- Fusion welded frame and sash corners
- Steel reinforced meeting rail and interlock
- Positive interlock at meeting rail
- Dual weather stripping
- Warm edge 11/16" insulating glass
- Heavy duty screen frame
- Block and tackle balance system
- Cam lock and keeper
- Tilt sash for easy cleaning
- Spring loaded tilt latches



### Slider Lock

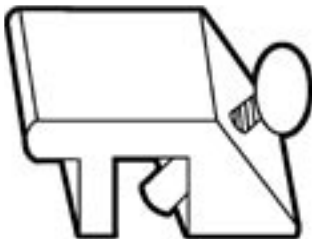

Fits all metal door & window frames, thumb screw locking. Allows for various vent openings.

**462435**

**J-Rail** 462762 21'

### Screws

8" x 1.5" hex head wood screw, painted white.

**264035** 50/Box

**264036** 500/Box

Size	Window w/Screen	With Integral 6 x 6 Grids	Obscure Glass W/Screen
14" x 21"	<b>462805</b>		
14" x 27"	<b>462750</b>		<b>462797</b>
14" x 35"	<b>462751</b>		
14" x 39"	<b>462777</b>		
14" x 40"			<b>462798</b>
14" x 53"	<b>462778</b>		
24" x 39"	<b>462752</b>	<b>462737</b>	
30" x 27"	<b>462753</b>	<b>462738</b>	
30" x 30"	<b>462780</b>		
30" x 35"	<b>462754</b>	<b>462739</b>	
30" x 39"	<b>462755</b>	<b>462740</b>	
30" x 52"	<b>462806</b>		
30" x 53"	<b>462756</b>	<b>462741</b>	
30" x 54"	<b>462807</b>		
30" x 58"	<b>462783</b>		
30" x 70"	<b>462808</b>		
36" x 27"	<b>462785</b>		
36" x 36"	<b>462786</b>		
36" x 40"	<b>462787</b>		
36" x 53"	<b>462758</b>	<b>462742</b>	
40" x 27"	<b>462788</b>		
40" x 40"	<b>462789</b>		
40" x 53"	<b>462790</b>		
46" x 27"	<b>462791</b>		
46" x 39"	<b>462759</b>	<b>462743</b>	
46" x 53"	<b>462760</b>	<b>462744</b>	
62" x 40"	<b>462795</b>		

## Series 800 Windows, Single Hung Tilt Sash, Vinyl Siding Frame

**NEW!**



### Standard Features

- Strong, durable, no maintenance all vinyl chambered frame never needs painting
- Heat fusion welding bonds the frame and sash corners, preventing water and air infiltration at the joints
- The narrow frame and sash profiles allow a large glass area for maximum exterior view
- Interlocking meeting rails provide a superior sealing system that will keep out wind and water
- Sash tilts inward and can be removed for cleaning from inside the home
- Full 3/4" insulating glass provides optimum thermal performance. Optional Low-E coated glazing available.
- Easy to use mull system allows windows to be joined with each other to create dramatic and interesting combinations
- J-Rail can be added to flush mount windows for lap siding applications

Size	Window w/Screen	With Integral 6 x 6 Grids
14" x 27"	<b>462831</b>	
14" x 39"	<b>462833</b>	
24" x 39"	<b>462834</b>	<b>462820</b>
30" x 27"	<b>462836</b>	<b>462821</b>
30" x 35"	<b>462837</b>	<b>462822</b>
30" x 39"	<b>462839</b>	<b>462824</b>
30" x 53"	<b>462840</b>	<b>462825</b>
36" x 39"	<b>462841</b>	
36" x 53"	<b>462842</b>	<b>462827</b>
46" x 39"	<b>462843</b>	<b>462828</b>
46" x 53"	<b>462845</b>	<b>462830</b>



Possible Grid Application



# Vertical Sliders

- Prepunched flush mount flange or lap leg return for lap siding
- Removable screens for easy cleaning
- Available in mill finish or enamel paint in white
- Coved glazed beading
- HUD approved
- Sloped sill for better drainage
- Continuous head; no vertical seams to catch water
- Tapered interlock
- Optional aluminum dimensional grids available

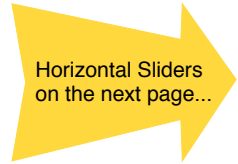

**462450** Latch/Spring Set

Other sizes available by special order.

Buck Size (or Actual Size of Window) Wd. X Ht.	White Flush Mount	Mill Flush Mount	White Lap Siding Applications	White Self-Storing Storm	White Replacement Screen	Mill Replacement Screen	Actual Screen Size
14-1/4" x 21-3/4"	<b>462701</b>	<b>462561</b>		<b>462602</b>			
18-1/4" x 21-3/4"		<b>462589</b>		<b>462625</b>			
24-1/4" x 21-3/4"		<b>462584</b>		<b>462626</b>			
30-1/4" x 21-3/4"	<b>462702</b>	<b>462579</b>		<b>462603</b>			
24-1/4" x 24-1/4"		<b>462569</b>		<b>462627</b>			
14-1/4" x 27-1/16"	<b>462703</b>	<b>462524</b>		<b>462607</b>		<b>462485</b>	13-5/8" x 13-1/32"
18-1/4" x 27-1/16"	<b>462721</b>	<b>462586</b>		<b>462628</b>			
22-1/4" X 27-1/16"	<b>462722</b>	<b>462573</b>		<b>462629</b>			
24-1/4" x 27-1/16"	<b>462704</b>	<b>462565</b>	<b>462353</b>	<b>462600</b>		<b>462481</b>	23-5/8" x 13-1/32"
30-1/4" x 27-1/16"	<b>462705</b>	<b>462506</b>	<b>462354*</b>	<b>462601</b>	<b>462725</b>	<b>462495</b>	29-5/8" x 13-1/32"
36-1/4" x 27-1/16"	<b>462706</b>	<b>462578</b>		<b>462608</b>			
40-1/4" x 27-1/16"		<b>462567</b>		<b>462609</b>			
46-1/4" x 27-1/16"	<b>462707</b>	<b>462496</b>		<b>462604</b>		<b>462492</b>	45-1/2" x 13-1/32"
24-1/4" x 30"	<b>462700</b>		<b>462349</b>				
30-1/4" x 30"	<b>462708</b>	<b>462497</b>	<b>462356</b>	<b>462605</b>		<b>462490</b>	29-1/2" x 13-1/2"
46-1/4" x 30"		<b>462588</b>		<b>462630</b>			
14-1/4" x 35-3/4"		<b>462587</b>		<b>462631</b>			
22-1/4" x 35-3/4"		<b>462571</b>					
24-1/4" x 35-3/4"		<b>462583</b>		<b>462632</b>			
30-1/4" x 35-3/4"	<b>462709</b>	<b>462563</b>	<b>462357</b>	<b>462606</b>		<b>462482</b>	29-5/8" x 17-5/8"
36-1/4" x 35-3/4"	<b>462710</b>	<b>462577</b>		<b>462612</b>			
40-1/4" x 35-3/4"	<b>462711</b>	<b>462585</b>		<b>462633</b>			
14-1/4" x 39-5/8"	<b>462712</b>	<b>462559</b>		<b>462613</b>		<b>462484</b>	13-5/8" x 19-13/16"
18-1/4" x 39-5/8"		<b>462581</b>		<b>462617</b>			
24-1/4" x 39-5/8"	<b>462713</b>	<b>462580</b>		<b>462618</b>			
30-1/4" x 39-5/8"	<b>462714</b>	<b>462507</b>	<b>462362</b>	<b>462610</b>	<b>462726</b>	<b>462494</b>	29-1/2" x 19-7/8"
36-1/4" x 39-5/8"	<b>462715</b>	<b>462522</b>		<b>462611</b>			
40-1/4" x 39-5/8"	<b>462716</b>	<b>462582</b>		<b>462619</b>			
46-1/4" x 39-5/8"	<b>462717</b>	<b>462694</b>		<b>462621</b>	<b>462727</b>	<b>462491</b>	45-1/2" x 19-7/8"
30-1/4" x 52-5/16"	<b>462718</b>	<b>462508</b>		<b>462614</b>	<b>462728</b>	<b>462487</b>	29-1/2" x 26-1/4"
14-1/4" x 53-5/16"		<b>462575</b>		<b>462634</b>			
30-1/4" x 53-5/16"	<b>462719</b>	<b>462525</b>	<b>462367</b>	<b>462615</b>	<b>462729</b>	<b>462493</b>	29-1/2" x 26-5/8"
30-1/4" x 53-5/16"			<b>462380**</b>				29-1/2" x 26-5/8"
36-1/4" x 53-5/16"	<b>462720</b>	<b>462499</b>		<b>462616</b>		<b>462488</b>	35-5/8" x 26-1/2"
40-1/4" x 53-5/16"		<b>462592</b>		<b>462635</b>		<b>462470</b>	39-5/8" x 26-13/16"
46-1/4" x 53-5/16"		<b>462498</b>	<b>462368</b>	<b>462622</b>	<b>462732</b>	<b>462489</b>	45-5/8" x 26-13/16"
30-1/4" x 58-5/8"		<b>462574</b>		<b>462623</b>		<b>462479</b>	29-1/2" x 29-3/8"

\* Also, **462348** with 6 x 6 grids

\*\* With 4 x 4 Grids

**New Items**

# Horizontal Sliders



- Prepunched flush mount flange
- Removable screens for easy cleaning
- Mill finish or enamel paint in white or bronze
- Coved glazed beading
- HUD approved
- Sloped sill for better drainage
- Continuous head; no vertical seams to catch water
- Tapered interlock
- Optional aluminum dimensional grids available

Other sizes available by special order.

Call Size* Wd. X Ht.	Mill Finish	White Self-Storing Storm
30" x 30"	<b>462526</b>	
30-1/4" x 14-7/16"	<b>462590</b>	<b>462636</b>
46-1/4" x 27-1/16"	<b>462593</b>	
46-1/4" x 39-5/8"	<b>462505</b>	<b>462624</b>

\* Call Width + 1/2" for Rough Opening



# Bathroom Windows

Obscure glass makes these windows perfect for bathrooms or any room where you want light and privacy.



Obscure glass, economical choice for bathrooms. 36" x 8" mill finish.

**462594** Window (does not open)

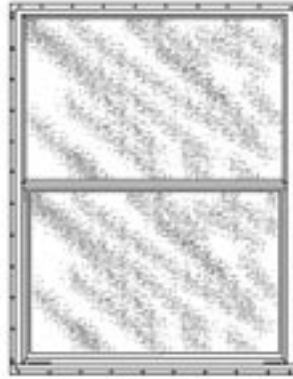

Vertical slider-type window with obscure glass, perfect for bathrooms. Mill finish.

**462572** 14" x 27"

Series 700 single hung tilt window with obscure glass, perfect for bathrooms. White vinyl PVC. With screen. *See page C-24.*



**462797** 14" x 27"

**462798** 14" x 40"

# Window Repairs

## Storm Rail

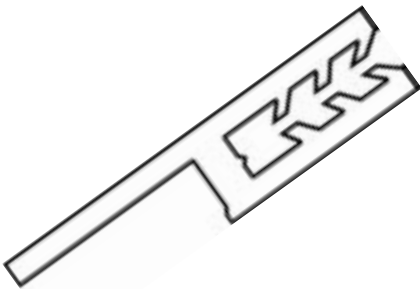

For replacing glass in windows. White PVC in 12' lengths.

**462414** 300/Ctn.

## Kinro Window Glazing



Vinyl strip for holding glass in place when replacing pane. White 12' lengths.

**462410**

## Glazing Channel

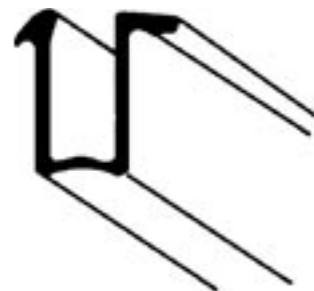

For replacing glass in sliding windows. 12'.

**462411** White

**462413** Brown

## Window Ventilation

### Adjustable Window Vent

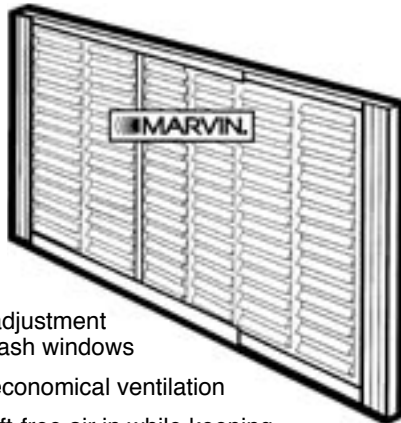

- Fingertip adjustment fits most sash windows
- Provides economical ventilation
- Allows draft-free air in while keeping weather and insects out
- Weather-resistant metal louver panels shed rain, sleet, snow
- Constructed w/almond-painted metal vents & varnished wooden ends
- Installs easily without tools from inside.

**462328** 10" High, Adjustable 22" to 37" Wide; 12/Ctn.

### VENTLINE Window Vent

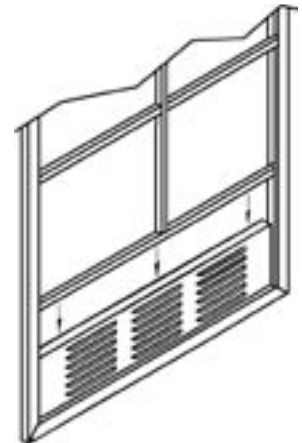

*2 Ways to Save Energy!*

- Easily installed in standard window frames. Just place vent in window track and close window to the top of the vent!
- Multiple louver design provides ventilation without letting in drafts, insects or weather
- 30" & 46" widths standard (actual: 29-1/2" & 45-1/2")
- Mill finish

**462326** 5" High for 30" Windows

**462325** 5" High for 46" Windows

## Decorator Blinds



### Mini-Blinds

1" PVC, lead-free with wand in classic white sized to fit manufactured housing windows. 10/Ctn.

- 260500** 32" x 30"
- 260501** 32" x 56"
- 260502** 38" x 56"
- 260503** 48" x 56"
- 260505** 23.5" x 54"
- 260506** 48" x 64"
- 260507** 35.5" x 54"

### Vertical Blinds

3.5" PVC, lead-free with wand in classic white, perfect for sliding glass doors.

**260504** 78" x 84"

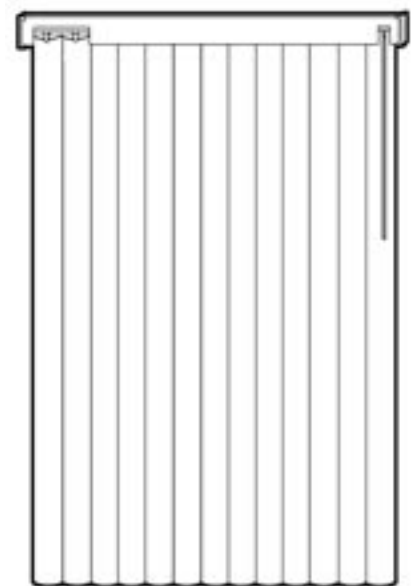

# Screen Repairs

## Screen Springs



Holds window screen in window.

**462428** Each; 250/Ctn.

## Corner Inserts

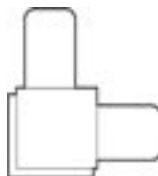

Plastic screen frame corner insert. 25/Ctn.

**262606** Gray (for Mill)  
**262609** Black (for Bronze)  
**262643** White

## Storm Window Clip #711



**461599**  
 Each; 25/Ctn.

## Screen Installer



Use convex roller end of installation tool to roll screen wire into slot of aluminum screen frame. Use concave roller end to roll plastic spine into slot over screen wire to hold it tightly in place.

**462402** 5/32"; 10/Ctn.  
**462400** 1/16"; 10/Ctn.

## Frame Extrusions w/out Spline



Aluminum framing in 13' lengths. Uses 5/32" spline.

**462425** Bronze    **462426** Mill Finish  
**462427** White

## Snap Fasteners

For screens, storm windows and many other holding applications. "Self-serve" colorful display bag punched for easy hanging. Each 3-3/4" x 4" bag contains 4 fasteners complete with screws. Seals windows against drafts.

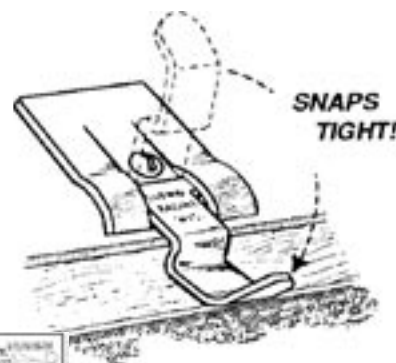

SNAPS TIGHT!

**462430** 36/Ctn.

Attractive display bag for easy in-store sales



## Screen Spline

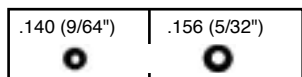

Replacement spline for metal and fiberglass screening.

**Gray**  
**462404** 9/64", 20'; 10/Ctn.  
**462406** 5/32", 20'; 10/Ctn.  
**462403** 5/32", 1000'

**Black**  
**462407** 9/64", 20'; 10/Ctn.  
**462408** 5/32", 20'; 10/Ctn.  
**462409** 5/32", 1000'  
**462405** 9/64", 250'

## Screen Wire



Fiberglass screen with 16 x 16 size mesh. Won't dent, corrode, or stretch. 100' roll.

Gray	Charcoal
<b>269002</b> 30"	<b>269005</b> 30"
<b>269001</b> 36"	<b>269008</b> 36"
<b>269004</b> 42"	<b>269007</b> 42"
<b>269000</b> 48"	<b>269006</b> 48"

## #800K Operator Kit

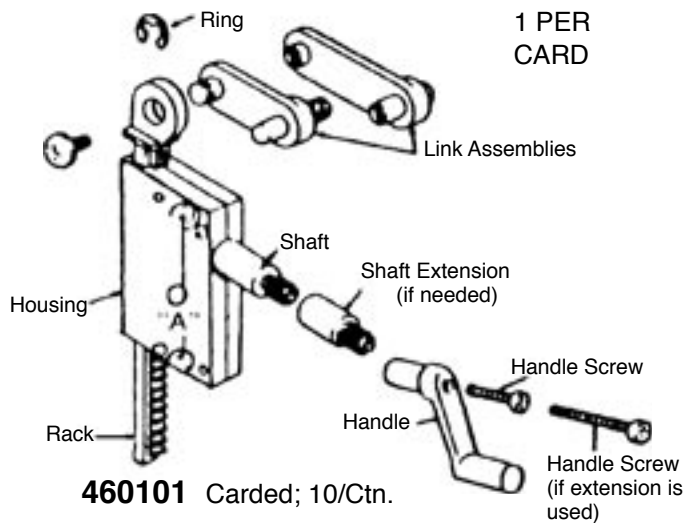

**460101** Carded; 10/Ctn.

1 PER CARD

## #1712 R.H. Operator

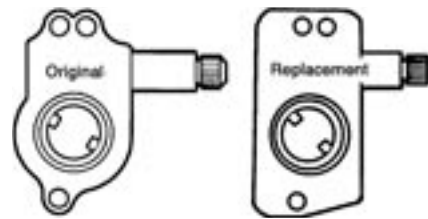

**461825**  
Poly Bagged;  
25/Bag

## #808 Side Mount Operator

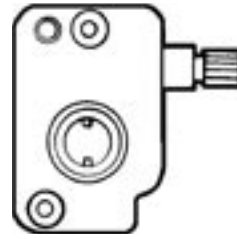

RH  
**460201** Skin Packed; 10/Ctn.  
**460203** 25/Bag

LH  
**460202** Skin Packed; 10/Ctn.  
**460204** 25/Bag

## #801K Operator Kit

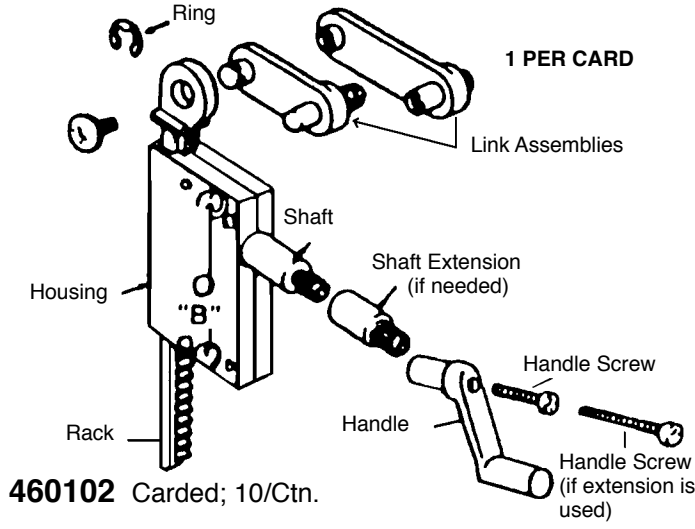

**460102** Carded; 10/Ctn.

1 PER CARD

## #761 Slant Sill Operator RH

**461109** Skin Packed; 10/Ctn.  
**461822** 25/Bag

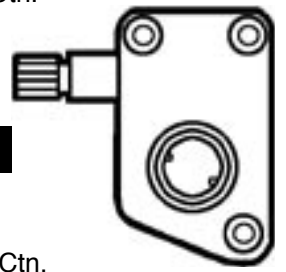

## #762 Slant Sill Operator - LH

**461818** Skin Packed; 10/Ctn.  
**461819** 25/Bag

(LH Shown)

## #816 Rack Operator

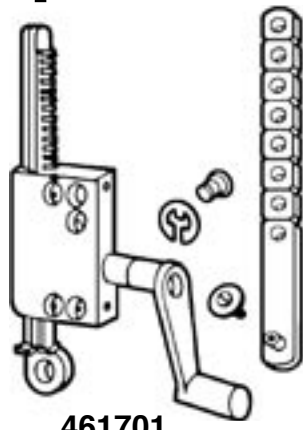

**461701**  
Carded; 10/Ctn.

## #747 Awning Type R.H. Operator

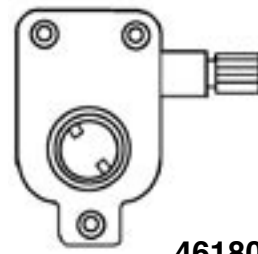

**461804**  
Skin Packed; 10/Ctn.

## #735 Side Mount Operator

R.H.  
**461106** Skin-Packed; 10/Ctn.  
**461105** 25/Bag



## #715 Side Mount Operator

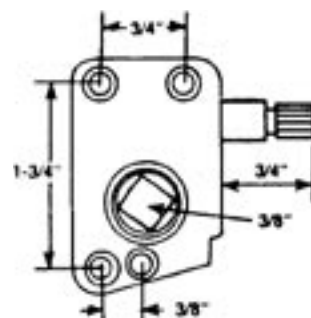

R.H.  
**461816** 25/Ctn.

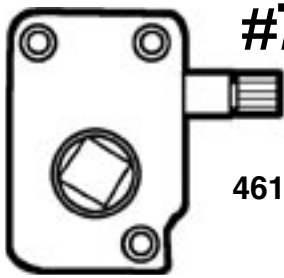

## #733 Side Mount

461815 R. H. Poly-bagged;  
25/Ctn.

## #787 Side Mount

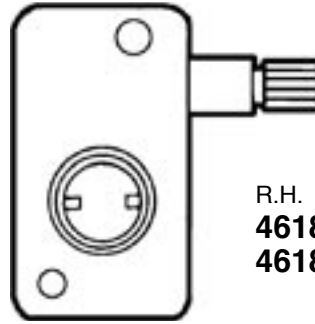

R.H.  
461802 Skin-Packed; 12/Ctn.  
461803 25/Bag

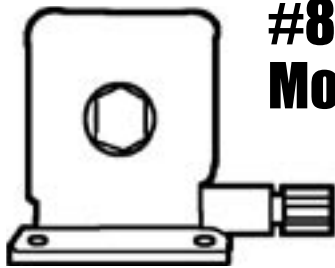

## #802 Center Mount

460402  
Hex 3/8";  
Skin-Packed; 12/Ctn.

## #812 Center Mount 5/16"

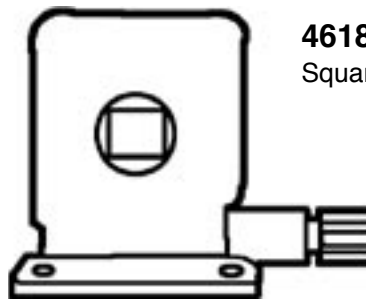

461831  
Square 5/16"; 25/Bag

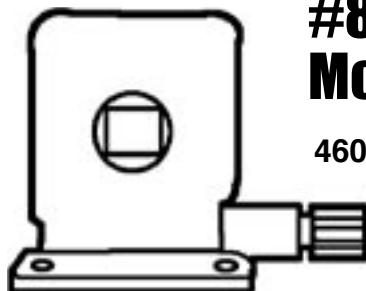

## #811 Center Mount 1/4"

460401 Square 1/4";  
Skin-Packed;  
12/Ctn.

## #803 Center Mount

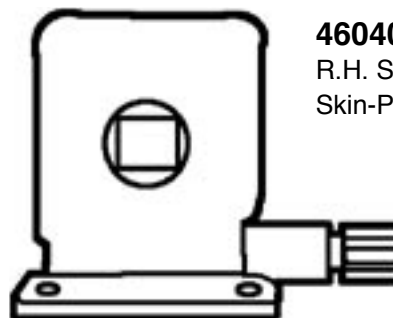

460403  
R.H. Square 5/16";  
Skin-Packed; 12/Ctn.

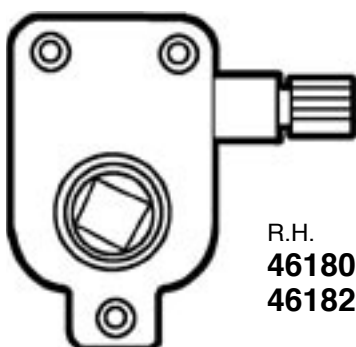

## #749 Awning Type

R.H.  
461807 Skin-Packed; 10/Ctn.  
461824 25/Bag

## #758 Side Mount

462639  
R. H.; 25/Ctn.

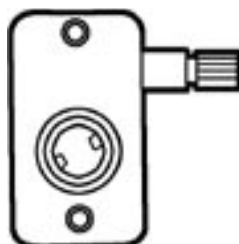

## #751 Side Mount

460404  
R. H.; 25/Ctn.

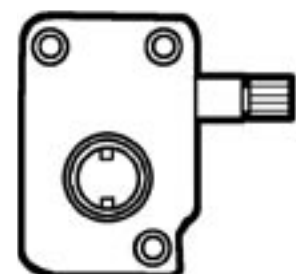



## #490 Flat Nylon Wing Clip

Six clips w/screws per pack.

461602 Skin-packed; 10/Ctn.



## #498 Offset Plastic Clip

Six clips w/screws per skinpack. 3/8" offset. 10/Ctn.

461604



## E-Rings

8 #328C per card

461845 1/4"



## #495 Plastic Clip

Six clips w/ screws per pack. 3/16" offset. 10/Ctn.

461832



## #492 Plastic Clip - Flat

Six clips w/screws per pack. Flat offset.

461603 10/Ctn.



## #350 Metal Zee Clip

Six clips w/screws per pack. Carded; 10/Ctn.

461601



## #760 Torque Bar Bearing

460310 Metal, Bulk; 25/Ctn.



## #719 Torque Bar Bearing

460300 25/Ctn.

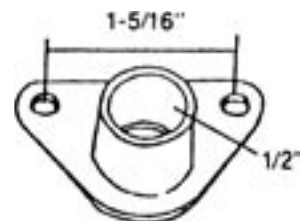

## #845 Torque Bar Bearing

461838 Metal, Bulk; 25/Ctn.



## #738 Torque Bar Bearing

460308 Nylon, Bulk; 25/Ctn.



## #74 Nylon Torque Bearing

460302 10/Ctn.

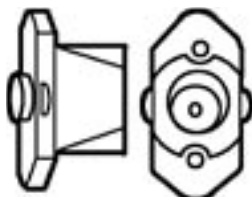

## #70 Nylon Torque Bearing

460301 10/Ctn.

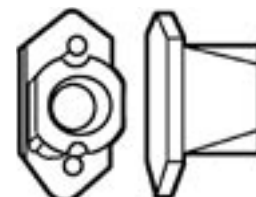

## #785 Phillips Torque Bar Arm

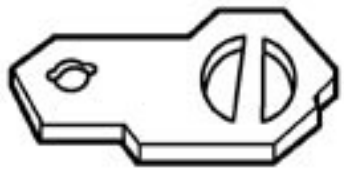

**461837** 1-11/16" Metal, Bulk; 25/Ctn.

## Metal Extension



Car  
**461301** 1/2"  
**461303** 7/8"  
**461304** 2"  
 100/Ctn.  
**461306** 2"  
**461305** 7/8"

## Plastic Knob Handle

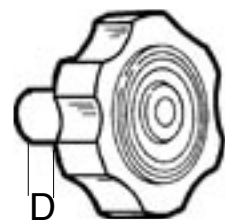

**461839**  
 D=1/2" Knob, Carded; 10/Ctn.

## #763 Nylon Torque Bar Bearing



**461598** Bulk; 25/Ctn.

## Plastic Crank Handles w/Screws

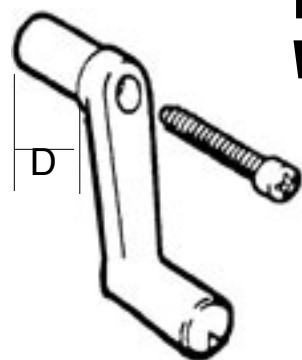

D  
**461833** 1"; 25/Bag  
**461834** 1-3/4"; 25/Bag  
**461823** 2-1/2"; 600/Ctn.  
**461204** 2-1/2" Carded; 10/Ctn.  
**461205** 3-3/16" Carded; 10/Ctn.  
**461206** 3-3/16"; 500/Ctn.

## Screws for Crank Handle



**461208** 2-1/2"; 100/Ctn.

## Metal Crank Handles with Screws

"D"  
**461201** 1" Carded; 10/Ctn.  
**461200** 1"; 750/Ctn.  
**461202** 1-3/4" Carded; 10/Ctn.  
**461203** 1-3/4"; 500/Ctn.  
**461827** 3-1/2"; Carded 10/Ctn.  
**461826** 3-1/2"; 350/Ctn.

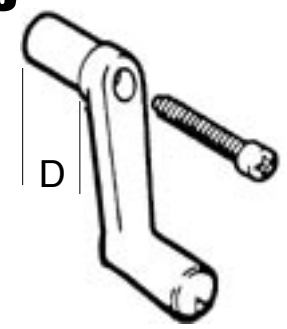

## Window Hinges

Sold in pairs only; 10/Ctn.

Stock#	WCM#	"A"	"B"	"C"	"D"	"E"	"F"
<b>461001</b>	786C	3/16"	2-3/16"	3-1/8"	7/16"	3-3/4"	W/Stud
<b>461101</b>	835P	3/16"	2-3/16"	3-1/8"	1"	4-3/8"	W/Stud

