

Taking Measurements:

There are many ways to measure for a door replacement, but Elixir recommends you measure your rough opening and select the replacement size which is closest to it.

For example, your rough opening measures 32-1/4" x 76-1/4". ALWAYS BACK DOWN TO THE NEAREST SIZE and order size 32" x 76".

To determine if your door is right or lefthanded, simply look at it from the outside of the home to see which side the hinges are on.

Installing the Door:

1. Make certain all mounting surfaces (siding seams included) are securely fastened and flat around perimeter of door opening.
2. Apply a suitable non-hardening sealant tape (such as Elixir 10-B Mobile Seal) to the backside of the door's mounting flange.
3. Do not remove any shipping clips or fasteners and keep the door closed and locked during the installation. Opening the door prior to the installation will destroy the pre-squaring by the manufacturer.
4. Insert the door assembly carefully into the rough opening. Make certain the door sill is secure on the floor. Move door to hinge side until it is firmly against hinge side stud.
5. Proceed to fasten door with screws. Drive the first 3 screws into the outer frame in the middle at the hinge side. Then, drive the next 3 screws in the middle of the outer frame on the lock side. Then, secure the balance of the hinge side, across the sill, up the lock side and the header.
6. Remove the shipping clips and open the door. Install the appropriate hardware.
7. If it is a house-type door with storm door, make certain 2 long screws are put through the storm door plunger bracket fastened to the jamb. This is to anchor the bracket securely to your hinge side stud.
8. If the house-type inner door is secured to the outer frame with butt type hinges (steel six-panel door only), run one long screw through each hinge on the jamb side to penetrate the hinge side stud.
9. The house-type door has an adjustable stop. Adjust the stop to the exterior of the inner door to insure a good seal.

If the above steps are followed, the door will be sealed and operate properly.

Steps 1, 2, 3 & 4

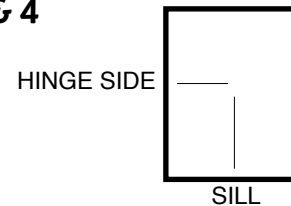

Steps 5 & 6

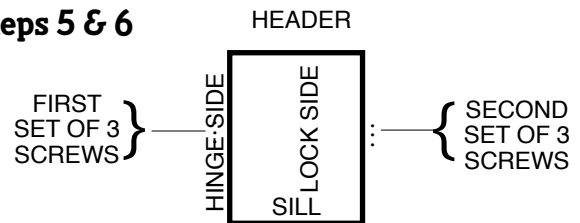

Steps 6 & 7

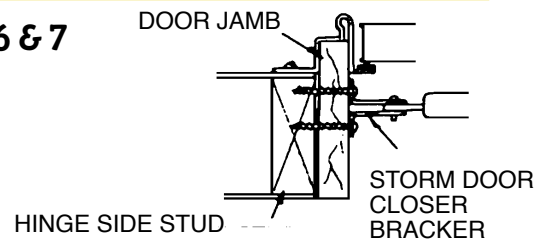

Steps 8

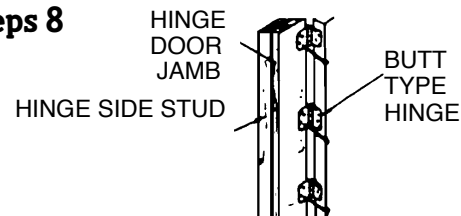

Steps 9

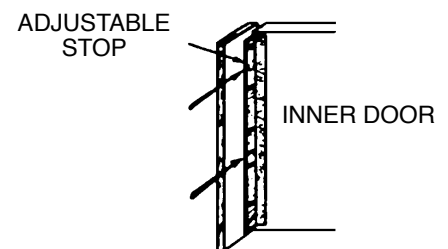



Series 6000 Housetype Combination Door



Shown with diamond window and standard storm door
Available with no window - "blank style"

Door Features:

- Painted Galvanized Steel**
 - Long Lasting
- Double Seal**
 - Folded Steel Edge with Weather Stripping
 - Protects Against Air, Light and Water
- Adjustable Door Stop**
- Swivel Bolts**
 - Easy Installation
- Sloped Threshold**
- Polyurethane Foam Core**
 - Highly Energy Efficient R-Values
- Quality Wood Jambs**
 - Finger Jointed Solid Pine

Door Color Options:

- Exterior:** White or Cream
- Interior:** White, Cream or Dark

Optional Hardware Sold on Page C-10

Blank Style

White Exterior/Dark Interior with Knocker/Viewer/Deadbolt

- 211098** 34" x 76" L/H Mill Finish Standard Storm
- 211099** 34" x 76" R/H Mill Finish Standard Storm
- 211106** 34" x 76" L/H White Storm

White Exterior/White Interior with Knocker/Viewer and **White Standard Storm**

- 211207** 34" x 76" L/H
- 211208** 34" x 76" R/H

White Exterior/White Interior with Knocker/Viewer and **Mill Standard Storm**

- 211219** 34" x 76" L/H
- 211220** 34" x 76" R/H



- 211201** 32" x 76" R/H
- 211202** 32" x 76" L/H
- 211214** 34" x 80" L/H
- 211215** 34" x 80" R/H

Quality Wood Jambs



Finger Jointed Pine with Adjustable Stop

10" x 10" Diamond Series 6000 Combo Door

Jamb Width: Outside: Inside: Storm Color: Storm Style:		4" White Dark White Standard	4" White Dark Mill Standard	6.5" White Dark Mill Standard	4" White White Mill Standard	4" White White White Standard	4" White White White Full View	6.5" White White White Standard	4.5" White White White Standard	4.5" White White White Standard	6.5" White White White Standard
32 X 72	L/H		211051		210870	210880					
	R/H		211052			210881					
32 X 74	L/H		210923								
	R/H		210924								
32 x 76	L/H	211079	211065	211118	210872	210874					
	R/H	211078	211066	211119	210873	210875					
32 x 78	L/H		211075								
	R/H										
32 x 80	L/H					211308					
	R/H					211309					
34 x 76	L/H	211083	211031	211110	210876	210878	210886	211180	211225	211227	
	R/H	211084	211082	211111	210877	210879	210888	211181*	211226	211228	
34 x 78	L/H	211088	210911	211112	211300	211304					
	R/H	211089	210910	211113	211301	211305					
34 x 80	L/H	211086	211030	211114	211302	211306		211182	211229	211231	
	R/H		211090	211115	211303	211307		211183	211230	211232	
36 x 76	L/H					210882					
	R/H					210883					
36 x 80	L/H		211116			211311					
	R/H		211117			211310					
38 x 76	L/H				211316						
	R/H				211317						
38 x 80	L/H						210928	211101			211184
	R/H						210929	211100			211185



211181* = Same door, but with deadbolt : 211096

Storm Door Features:

- Built-in Drip Cap
- 1-1/8" Thick w/1/8" Thick Tempered Safety Glass

Style Options:

- Standard
- Full-View
- All Glass Full-View

Color Options:

- Mill
- White
- Bronze



Standard



All Glass Full-View



Full-View

Series 6000 Housetype Combination Door (Cont.)

9-Lite 20" x 36" (Cottage Style)

White Ext./White Int. with Standard Storm in White

211136	34 x 76 L/H w/Deadbolt
211137	34 x 76 R/H w/Deadbolt
211138	34 x 78 L/H w/Deadbolt
211139	34 x 78 R/H w/Deadbolt

NEW! 6.5" Jambs

White Ext./White Int. with Standard Storm in White w/6.5" Jambs

211166	34 x 76 R/H
211167	34 x 76 L/H
211165	34 x 80 L/H

4.5" Jambs **NEW!**

White Ext./White Int. with Standard Storm in White w/4.5" Jambs

211235	34 x 76 L/H
211236	34 x 80 L/H



Fan Window Style

Classic white door with fan-shaped window is white inside and out with matching white jambs. Drilled for deadbolt.

210917	34" x 76" LH; Std. White Storm
210921	34" x 76" RH; Std. White Storm
210914	34" x 76" LH; Full View White Storm
210915	34" x 76" RH; Full View White Storm
211233	34" x 76" LH; Std. White Storm with 4.5" Jambs
211234	34" x 76" RH; Std. White Storm with 4.5" Jambs

NEW!



Special Order Doors

Can't find the size or style you're looking for?

We can special order a large variety of doors, like the ones seen here and many others. Ask your sales representative for more information.





Series 9000 Vinyl Steel Combo Door - Six Panel Style



Door Features:

Vinyl Laminated Galvanized Steel

- Our Thickest Gauge of Long Lasting Steel
- Upgrade from Series 8000 Steel

Double Seal

- Folded Steel Edge with Weather Stripping
- Lifetime Warranty Weather-Stripping
- Protects Against Air, Light and Water
- Easy Installation

Polyurethane Foam Core

- Highly Energy Efficient R-Values

Quality Wood Jambs

- Finger Jointed Solid Pine

Three-Finger Vinyl Sweep

Swivel Bolts

Shown with all glass full-view storm and six-panel door

All stocked doors have knocker with viewer and are drilled for deadbolt.

Door Color Options:

White Only - Both Sides

Quality Wood Jambs



Finger Jointed Pine with Adjustable Stop

For storm door features, see page C-3

211103 and 211102* come with deadbolt*

		Jamb Width: 4"	4"	4"	4"	6.5"
		Door Inside: White	White	White	White	White
		Door Outside: White	White	White	White	White
		Storm Color: White	White	Mill	White	White
		Storm Style: Full View	Full View	Standard	Standard	Standard
		All Glass				
32 x 76	L/H				211131	211216
	R/H				211132	211217
34 x 76	L/H	211755	211150	211121	211122	211140
	R/H	211756	211151	211120	211123	211141
34 x 78	L/H		211154		211144	
	R/H		211162		211145	
34 x 80	L/H		211148	211125	211146	211142
	R/H		211149	211124	211147	211143
36 x 76	L/H	211160				
	R/H	211161				
36 x 80	L/H				211186	
	R/H					
38 x 76	L/H		211163	NEW!		
	R/H		211164			
38 x 80	L/H		211156		211318	211103*
	R/H		211157		211319	211102*
38 x 82	L/H		211158			
	R/H		211159			

Optional Hardware Sold on Page C-10

Prices and Specifications Subject to Change without Notice

Series STR 7000 Residential Vinyl Steel Combination Door



Shown with full-view storm door

Optional Hardware Sold on Page C-10

Door Features:

Vinyl Laminated Galvanized Steel

- Our Thickest Gauge of Long Lasting Steel
- Upgrade from Series 8000 Steel

Lifetime Warranty Weather-Stripping

- Protects Against Air, Light and Water

Residential 1-3/4" Door

- Our Very Best Door

Polyurethane Foam Core

- Highly Energy Efficient R-Values

Quality Wood Jambs

- Finger Jointed Solid Pine

Six-Finger Vinyl Sweep

Swivel Bolts

- Easy Lock Installation

Door Color Options:

White or Brown



Pictured Above: Decorative Oval 211210 and 211211. Other sizes and designs are available by special order.



*(Left) 4 Panel w/ Fan: sunburst window with beveled glass, floral pattern and brass caning replace top two panels.

NEW!

Jamb Width: Door Inside: Door Outside: Storm Color: Storm Style:	SIX PANEL			4 PANEL W/FAN*	COTTAGE	OVAL	DECORATIVE OVAL	
	4" White White White Full View	4" White White White Standard	6.5" White White White Standard	4" White White White Full View	White White White Full View	White White White Full View	White White White All Glass	
34 x 76	L/H	211750	211722	211740	211206	211105	211197	211210
	R/H	211751	211723	211741	211205	211104	211198	211211
34 x 78	L/H							
	R/H							
34 x 80	L/H	211748	211746	211742				
	R/H	211749		211743				
38 x 80	L/H					211108	211199	
	R/H					211109	211200	



Series 8000 Vinyl Steel Housetype Combination Door



Door Features:

Vinyl Laminated Galvanized Steel

- Long Lasting
- 60% Thicker than Series 6000 Doors
- More Dent and Scratch Resistant

Double Seal

- Folded Steel Edge with Weather Stripping
- Protects Against Air, Light and Water

Adjustable Door Stop

Three-Finger Vinyl Sweep

Sloped Threshold

Swivel Bolts

- Easy Installation

Polyurethane Foam Core

- Highly Energy Efficient R-Values

Quality Wood Jambs

- Finger Jointed Solid Pine

Door Color Options:

White Only - Both Sides

Quality Wood Jambs



Finger Jointed Pine
with Adjustable Stop

Optional Hardware Sold on Page C-10

Fan Lite Series 8000 Combo

(Pictured) Elegant white door white standard storm door. Door is drilled for deadbolt. Entrance lock and deadbolt are available in brass. Keyed alike for convenience. 4.5" jambs. Other sizes and designs are available by special order.

210970 Fan Lite, 32" x 76" LH

210971 Fan Lite, 32" x 76" RH



Shown with Optional 9 Lite/Cottage Window

Door Features:

Vinyl Laminated Galvanized Steel

- Long Lasting
- 60% Thicker than Series 200 Doors
- More Dent and Scratch Resistant
- Withstands Winds in Excess of 140 MPH

Double Seal

- Folded Steel Edge with Weather Stripping
- Protects Against Air, Light and Water

Swivel Bolts • Easy Lock Installation

Polyurethane Foam Core • Highly Energy Efficient R-Values

Adjustable Striker Plates

Optional Hardware Sold on Page C-10



Fan Lite

210960 34" x 76" LH White/White w/DB

210961 34" x 76" RH White/White w/DB

Red = New Items

NEW!

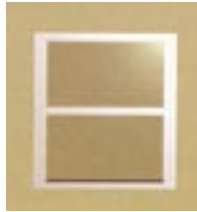

18" x 20" Slider Window

210962 36" x 80" LH White/White

210963 36" x 80" RH White/White



10" X 10" Diamond

210965 32" x 74" LH White/White

210966 36" x 80" LH Gray/Gray

210967 36" x 80" RH Gray/Gray

210968 36" x 80" RH White/White

210969 36" x 80" LH White/White



NEW!

10" x 10" Square

210819 34" x 72" LH White/White
w/MF Frame

210821 34" x 72" RH White/White
w/MF Frame

NEW!

Blank

210964 36" x 80" LH White/White
(shown at right)



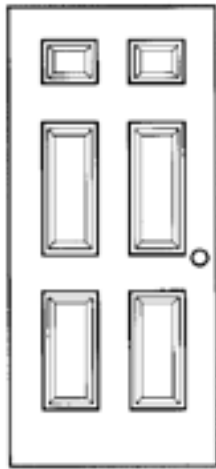

Series 300 6-Panel

Same quality features as the 400 Series with six raised panels. White door and frame only.

211126	32" x 72" LH	211129	34" x 76" RH
211127	32" x 76" RH	211130	34" x 76" LH
211128	32" x 76" LH	210755	73" x 72" LH
211107	36" x 80" RH	210756	73" x 72" RH

NEW!



Reinforced Commercial Grade

Commercial Grade with 2 x 4 Construction

BLANK DOORS

211175	36" x 80" LH Blank White/White
211176	36" x 80" RH Blank White/White

PANIC DOORS

210957	36" x 80" LH Square 10" x 10" White/White w/Panic Bar
210958	36" x 80" RH Square 10" x 10" White/White w/Panic Bar

Red = New Items

Hardware

Hardware is sold as an option on these doors for economy, so you buy only what you need.

295040	Lock*	295041	Deadbolt* Combo SS, Master-Keyed	295042	Deadbolt Combo* Brass, Master-Keyed
212009	Drip Cap f/72" door				
212011	Drip Cap f/32" or less door				
212012	Drip Cap f/34" door	212013	Drip Cap f/36" door	212014	Drip Cap f/48" door
212018	Drip Cap f/53" door	265506	Threshold f/32" or less	265507	Threshold f/34" door
265508	Threshold f/36" door	210601	Safety Chain Kit	210602	S Hooks
265510	72" Threshold				

* These items come without a bolt or strike, which are already installed on these doors

Blank Double Door Series 100

Same quality features as Series 200, but with double doors.

- 211168** 72" x 72," White/Dark
- 211169** 72" x 72," Cream/Cream
- 211172** 61" x 72," White/Dark
- 211173** 72" x 80," White/White
- 211174** 65" x 72," White/Dark
- 211155** 61" x 80," White/White
- 211170** 72" x 72," White/White
- 211171** 60" x 72," White/White

Cottage Double Door Series 100

- 211213** 72" x 76," LH White/White Mill Finish Frame
- 211209** 72" x 80," LH White/White Mill Finish Frame



HINT:

Many of these doors are used primarily on portable buildings.



Series 200 Manufactured Home Exterior Door



Door Features:

Painted Galvanized Steel

- Long Lasting

Double Seal

- Folded Steel Edge w/Weather Stripping
- Protects Against Air, Light and Water

Swivel Bolts

- Easy Lock Installation

Polyurethane Foam Core

- Highly Energy Efficient R-Values

Adjustable Striker Plates

Door Color Options:

Exterior: White or Cream

Interior: White, Cream or Dark

Frame Color Options:

White, Cream or Bronze

See Next Page for More....

		10" x 10" Diamond Window				18" x 20" Slider Window			Cottage Window	
OUTSIDE:	INSIDE:	White Dark MF Frame	White White WH Frame	White White MF Frame	Cream Dark MF Frame	White Dark MF Frame	White White WH Frame	White White MF Frame	White White WH Frame	White White MF Frame
30 x 72	LH	211035	210866			210800				
	RH		210867			210799				
32 x 72	LH	210916	210850	211820		210801	211400	211846	210885	211875
	RH	210920	210849	211800		210802	211401	211847	210884	211874
32 x 74	LH	211033				210810	211402	211848	211410	211876
	RH	210935				210812	211403	211849	211411	211877
32 x 76	LH	210919	210854	211802	210826	210806	211404	211850	210887	211878
	RH	210797	210855	211805		210798	211405	211851	210896	211879
32 x 78	LH	210897	210912	211806		210901	211406	211852	211412	211880
	RH	210936	210913	211807		210902	211407	211853	211413	211881
32 x 80	LH		210926	211808		210908	211408	211854	210946	211882
	RH		210927	211809			211409	211855	210947	211883
34 x 76	LH	210918	210858	211812	210827	211029	210840	211858	210889	211886
	RH	210904	210859	211813		210905	210841	211859	210890	211887
34 x 78	LH	210898	210862	211814		210899	210842	211860	210891	211888
	RH		210863	211815			210843	211861	210892	211889
34 x 80	LH	210903	210864	211816		210909	210844	211862		
	RH		210865	211817			210845	211863		
36 x 60	LH									
	RH									
36 x 63	LH									
	RH									
36 x 69	LH									
	RH									
36 x 70	LH									
	RH									
36 x 72	LH		210829	210830					210893	211908
	RH							210846		
36 x 74	LH							211865		
36 x 76	LH		210868	211820			210836	211868		210861
	RH		210869	211821			210837	211869		210853
36 x 80	LH	210814	210816	210796	210834	210906	210838	211870	210851	211892
	RH	210833	210817	211822		210907	210839	211871	210852	211893
48 x 63										
48 x 66										
48 x 72										

Red = New Items

Series 200 Exterior Doors (Cont.)

Red = New Items

		Blank						Fan Lite
OUTSIDE:	INSIDE:	White Dark MF Frame	White* White WH Frame	White White MF Frame	Cream Dark MF Frame	White Buck MF Frame	Buck Buck MF Frame	White White WH Frame
30 x 72	LH	210804	211179	211900				
	RH							
32 x 72	LH	210805	210790	211187				
	RH							
32 x 74	LH	210786	211178	211901				
	RH							
32 x 76	LH	210811	210791	211827	210823			210847
	RH							210848
32 x 78	LH	210780	210781	211828				
	RH							
32 x 80	LH		210835	211829				
	RH							
34 x 74	LH			211194				
	RH							
34 x 76	LH	210809	210807	211835	210824			210856
	RH							210857
34 x 78	LH	210779	210792	211836				
	RH							
34 x 80	LH		210793	211837				
	RH							
36 x 60	LH			211190				
	RH							
36 x 61	LH		211196					
	RH							
36 x 63	LH			211193				
	RH							
36 x 69	LH			211191				
	RH							
36 x 70	LH			211192				
	RH							
36 x 72	LH	210775	211189					
	RH							
36 x 74	LH			211194				
36 x 76	LH	210776	210774	211840				
	RH							
36 x 80	LH	210789	210794	211841	210828			
48 x 63	LH			210785				
48 x 66	LH			211195				
48 x 72	LH			210782	210777	210778	210761	
48 x 74	LH			210764				
48 x 76	LH			210783		210768	210762	
48 x 80	LH			210784	210766	210767		

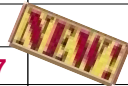

Replacement Parts for Doors



210745 10" x 10" Diamond Window, Brown
210747 10" x 10" Diamond Window, White



210746 4" x 24" Window, Colorless Obscure Glass w/White Frame



210744 20" x 36" Cottage

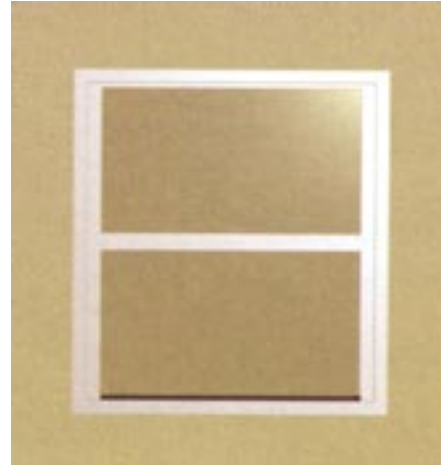

210803 Mill Finish 18" x 20" w/Screen
210795 White 18" x 20" w/Screen
210748 18" x 20" Replacement Screen, White
210749 18" x 20" Replacement Screen, Mill

212016 Brass Viewer
212017 Chrome Viewer
212022 Brass Knocker/Viewer
212010 Chrome Knocker/Viewer

210995 Combo Door Hinge Brass
219001 Weather Stripping 30'
210455 Door Shipping Clip

Portable Buildings

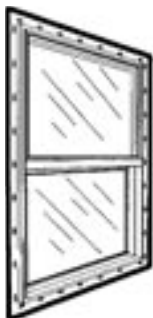

Portable Building Windows

462569 24-1/4" x 24-1/4" Mill Finish
462780 Vert. Slider 36 x 40 Brown
462348 Vertical Slider 30-1/4" x 27-1/16" White, Lap Application with Grids



Screws

262651 8" x 3/4"; 1000/Box
262653 8" x 3/4"; 10,000/Box

Storm Doors



Heavy-gauge, hollow, aluminum door frame, reinforced with 14-gauge corner gussets. Fiberglass screen resists impact without permanent deformation.

All doors pictured are right-hand doors.

Sliding window tested in 2,500 uses without failure (equivalent to more than 20 years of normal use). 1/8" tempered safety glass installed in all standard size doors.

NOTE: Hardware NOT included.

Rough Opening		Mill Standard	White Standard	Bronze Standard	White Full View	White All Glass
32 x 72	L/H	210808				
	R/H	210815				
32 x 76	L/H	211006	211007	211059		
	R/H	210818	211008	211060		
34 x 76	L/H	211020	211053	211055	211133	211023
	R/H	211013	211054	211061	211134	211024
34 x 78	L/H	211012	211062		211135	
	R/H	211015				
34 x 80	L/H	211010	211064			
	R/H	211014	211063			
38 x 80	L/H		211017			
	R/H		211016			

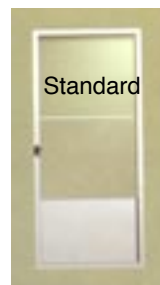
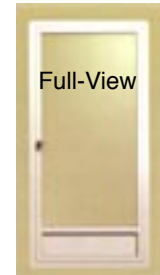

Other sizes and styles available by special order.

Storm Door Replacement Parts

- 212036** Hardware Kit for Mill Storm (incl. handle & closure kit)
- 212038** Hardware Kit for White Storm (incl. handle & closure kit)
- 210450** Top Glides
- 210452** Clips & Springs
- 210945** Screen f/Std. Door 27 x 29 MF
- 210948** Screen f/Std. Door - White
- 210470** Clip/FV Storm White

Pushbutton Latch

- Anti-lockout feature
- 1-3/4" mounting hold spacing
- Installs in three 1/4" holes
- Carded

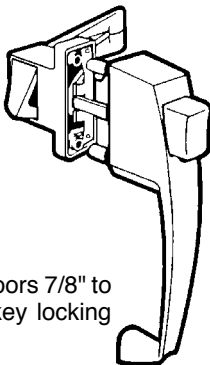

For all outswinging doors 7/8" to 1-1/4". Converts to key locking set with key plug.

- 291302** Black; 10/Ctn.
- 291301** Aluminum; 10/Ctn.
- 291300** White

Storm Door Closer



Smooth, silent regulated closing for storm and screen doors. Permanently sealed tube. Positive-latching mechanism. Shock absorber action.

- 210701** Aluminum
- 210702** Black
- 210700** White

Pushbutton Key Plug

for Storm Door Locks

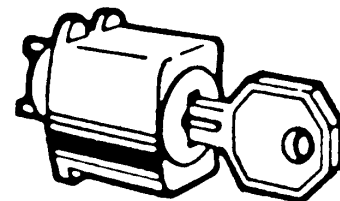

Fits most rectangular pushbutton storm doors. Furnished with calibrated metal spindle and spring.

- 291305** Black; 10/Ctn.

1-3/8" Interior Doors

Standard Doors:

Made using a patented process that produces a simulated, textured woodgrain for a durable surface that withstands vigorous handling and remains problem free. Now your homes can feature the lasting beauty and classic styling of wood that will easily coordinate with any decor.

Six-Panel Molded Doors:

These doors have the rich, warm look of wood and luxurious sculpted detailing that attracts home buyers and pays off in quicker, more profitable home sales. Rivaling the beauty of solid wood doors, they're more dense than natural wood and resist cracking, shrinking and swelling. Door facings are manufactured with high density fiberboard that is durable and affordable. In classic white or harvest oak. Uses non-mortise hinges.



	Standard		Six Panel Molded	
	Harvest Oak	Flushed White	Harvest Oak	White
24" x 78"	210710	210715	210687	210705
24" x 80"	210729	210725	210680	210735
26" x 78"	210711	210716	210688	210706
26" x 80"	210730	210726	210681	210736
28" x 78"	210712	210717	210689	210707
28" x 80"	210731	210727	210682	210737
30" x 78"	210713	210718	210690	210708
30" x 80"	210732	210728	210683	210738
32" x 78"	210721	210720	210691	
32" x 80"	210743	210742	210684	210734
36" x 78"	210714			
36" x 80"	210741	210739		

All Colors May Not Be Available At All Locations • Other colors available by special order.

Interior Door Hinges

Non-mortise hinges are poly-bagged in pairs with 8 screws.

- 210990 Brass
- 210991 Brushed Nickel



Extended leaf hinges are poly-bagged in pairs with screws.

- 210989 Brass
- 210992 Brushed Nickel



Six Finger Hinges

Six screw flanges.

- 210993 Satin Nickel

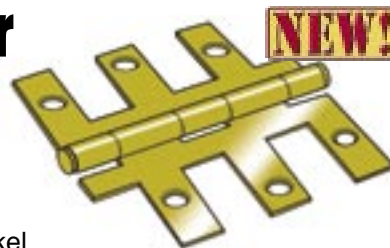

Combo Door Hinges

- 210995 Brass
- 210604 Steel



Patio Doors

Outswinging Double French Doors

These are part of the Series 400 Exterior Doors featured on page C-9. Please refer to that page for construction details and features.

- 212040 72" x 76" RH
- 212041 72" x 76" LH



Sliding Glass Patio Door

Series 870. White vinyl, insulated glass and keyed lock. 72" H x 77" W. (71.5" x 76.5" buck size.)

XO: From the outside looking in, left panel slides and right panel is stationary.
OX: From the outside looking in, right panel slides and left panel is stationary.

FOR LAP SIDING APPLICATIONS, 72" H x 77" W

- 212029 "OX" 212028 "XO"

FOR FLUSH MOUNT APPLICATIONS, 72" H x 77" W

- 212026 "OX" 212025 "XO"



36" x 75" 9/16 Screens for M/1000 Style

- 212007 Mill Finish
- 212008 White

- 212030 Style 870SGD Screen Insert, Fits 71.5" x 76.5" Door; White; Screen Measures 36" x 74-3/8"

Patio Door Locks

- 290405 Patio Door Lock (Old Style)
- 290406 Patio Door Lock (New Style) for Vinyl Doors

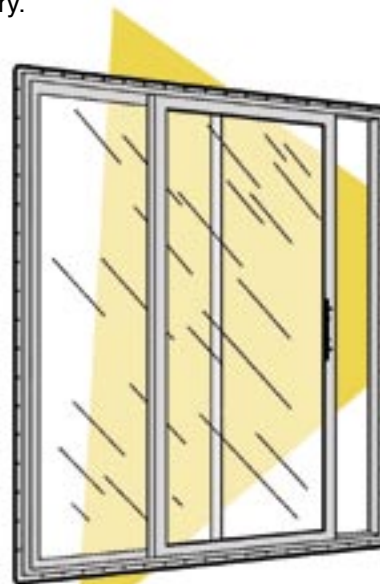

Universal Sliding Patio Door Lock

Universal sliding glass door lock features extended guide to prevent lift and opening. Also guarantees lock alignment. Fits most doors.

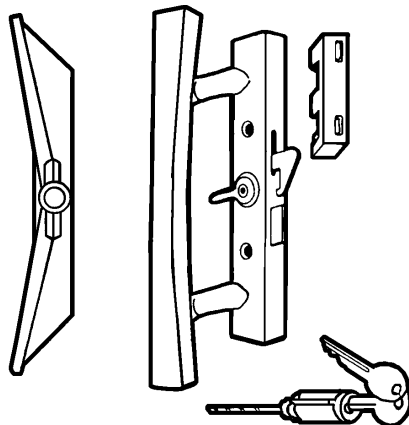
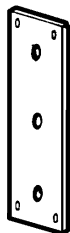

290405 10/Ctn.
290407 Lock Cylinder Only

Nite Lock Pin

For Sliding Patio Door

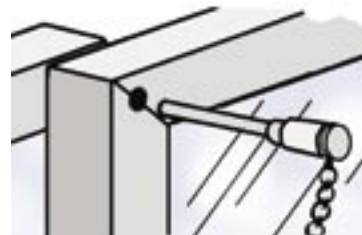

Protects against burglary. Easy installation. Out of children's reach.

469000

Sliding Door Lock Kit

Universal, recessed sliding door lock kit comes with easy to follow instructions. (Found on 1999 and older homes.)

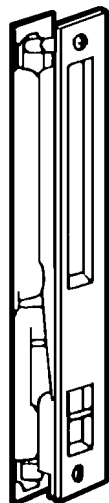

290408

Patio Screen Roller #197C

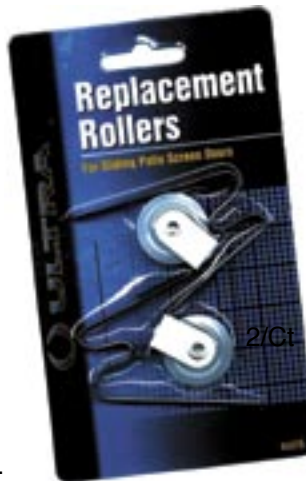

461702 12/Ctn.

Elixir Key



295060 Blank
295059 Master Key

Elixir Striker Plates



295065 For Elixir Entrance Lock (Doors produced prior to Aug. 1992)
295066 For Elixir Dead Bolt Lock (Doors produced prior to Aug. 1992)
295070 For Elixir Regular Doors
295071 For House-type (Combo) Doors

Patio Door Roller

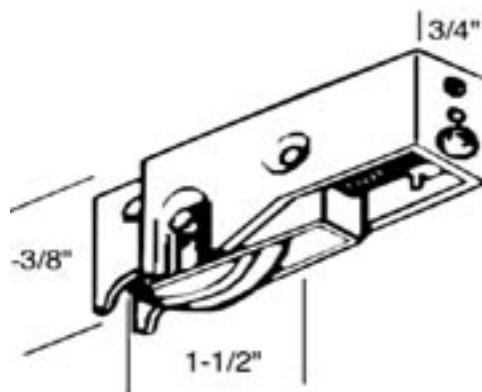

461703

Prices and Specifications Subject to Change without Notice

Entrance Lock Only

- Seamless one-piece knob
- Auto-release and panic-proof
- Patented revolving collar adj. drive-in latch bolt for easy installation



295046 Master-keyed, Adj. SS
295077 Master-keyed, Adj., Brass

295068 Mortise Plate
295059 Replacement Key for Master-Keyed Locks

Deadbolt Lock Only

- Solid brass cylinder housing
- Patented revolving collar drive-in latch bolt for easy installation
- Solid brass latchbolt with anti-sawing roller insert



295054 Single, Stain. Steel
295078 Single Deadbolt, Brass
295079 Double Deadbolt, Brass

LOCWARE Combo Lock Sets



Keyed-alike entrance and deadbolt lock set. Great security, specially designed for manufactured home doors, tested residential grade. Adjustable bolts, single deadbolt.

295125 Brass
295126 Stainless Steel

Elixir Deadbolt Drive-In Latch Bolt

2-3/8" drive-in w/swivel bolt.

295032 12/Ctn.



295061 Patented revolving collar adj. drive-in latch bolt for easy installation

Elixir Entrance Drive-In Latch Bolt



Adjustable swivel latch bolt only. Slides from 2-3/8" backset to 2-3/4".

295050 24/Ctn.

EZSet Locks



290811 Shown

QUALITY

- All metal construction
- All exposed components are brass or stainless steel
- Nickel plated brass key

SECURITY

- 5 Pin tumbler cylinder
- Solid brass cylinder core
- Adjustable 2-3/8" to 2-3/4" backset dead latch on entrance function

CONVENIENCE

- Cylinder removable for rekeying
- Reversible for RH/LH door
- Adjustable for 1-3/8" to 1-3/4" door thickness
- 2-3/8" to 2-3/4" adjustable backset
- Easy installation
- Can be keyed alike with any E-Z Set lockset

Lock with Square Latch Bolt

2-1/8" diameter face hole, 1" diameter latch hole. Comes with adjustable square latch bolt. 20/Ctn.

290826 Stainless Steel

290811 Bright Brass



Drive-In Entrance Lock

2-1/8" diameter face hole, 1" diameter latch hole. Comes with adjustable round, drive-in latch bolt. 24/Ctn.

290827 Stainless Steel

290828 Master-keyed Stainless Steel, #69777

290812 Bright Brass

290813 Master-keyed Bright Brass, #69777

E-Z Set Deadbolt Lock

1-1/2" to 2-1/8" diameter door face hole. 1" diameter latch hole. 1" projection. 20/Ctn.

290816 Double Bright Brass

290831 Double Stainless Steel

290815 Single Bright Brass

290830 Single Stainless Steel

Combo Set

Single deadbolt and entry knob keyed alike in a single box. Adjustable drive-in latch.

290810 Bright Brass

290825 Stainless Steel

Master Key

Fits EZ Set entrance lock with drive-in latch bolt. Master-keyed. #69777.

290818



Interior Door Strike Plate

Standard latch for 1/2" projection dead bolt. 24/Ctn.

290817 Bright Brass

290820 SS



Drive-In Bolt

Drive-in dead latch adjustable back set.

290819



Valterra Locks



295039 Knob/Lever



290805 Knob/Knob

Adjusts to fit 2-3/8" or 2-3/4" backset and standard or drive-in style latches. Eliminates the guesswork in determining which lock is needed for replacement. Stainless steel finish. Panic-proof knob always free to open. Rekeyable.

Interior Lever Lock



NEW!

NOW IN BRUSHED NICKEL

- 290110** Passage, Polished Brass
- 290111** Privacy, Polished Brass
- 290112** Passage, Brushed Nickel
- 290113** Privacy, Brushed Nickel

Decorator Plastic Lock



For doors 1" to 1-1/2" thick. Will not rust, tarnish or corrode. 2-3/8" backset, 7/8" diameter. Standard full lip strike. Smooth-turning. Shrink packaged. 50/Ctn.

- 291901** Privacy, Coffee
- 291900** Privacy, Almond
- 291700** Passage, Almond
- 291701** Passage, Coffee

Passage & Privacy Lock

NEW!

NOW IN BRUSHED NICKEL



Conical knob, contemporary design. 2-3/8" round drive-in latch.

- 290105** Passage, Polished Brass; 30/Ctn.
- 290106** Privacy, Polished Brass; 30/Ctn.
- 290107** Replacement Bolt, Polished Brass
- 290103** Passage, Brushed Nickel; 30/Ctn.
- 290104** Privacy, Brushed Nickel; 30/Ctn.

Door Clip



Keeps doors closed and secure during transport or whenever you need to restrict access.

210455

Lock Installation Tool Kit



For fast and easy installation of most locksets and deadbolts; fits most popular electric and cordless drills. Blade-mandrel and bit are high quality heat treated and hardened. Contains one 2-1/8" diameter high carbon steel high speed holesaw and mandrel, and one 1" high speed wood power bit. Will saw through metal or wood. Carded.

390500 12/Ctn.

Help-U-Lock

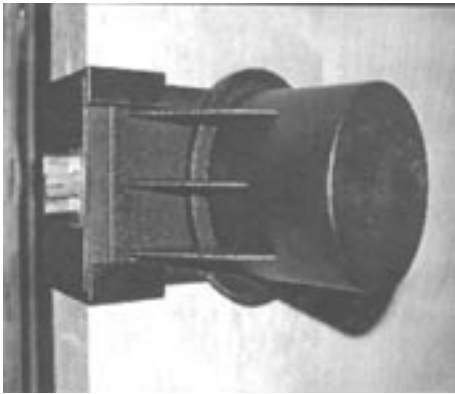

Reduce your risk and liability by stopping back door falls and after-hour theft. Secures the door from the inside of the home with a unique design that is inexpensive and easy to use. Just install and forget it!

290100

Self-Adhesive Stop

211002 White; 100/Ctn.



Knob/Wall Protector

High impact material can be painted or papered. Foam on back absorbs shock. 1/4" total thickness. Washable. White.

211003 3" Dia.

211005 5" Dia.

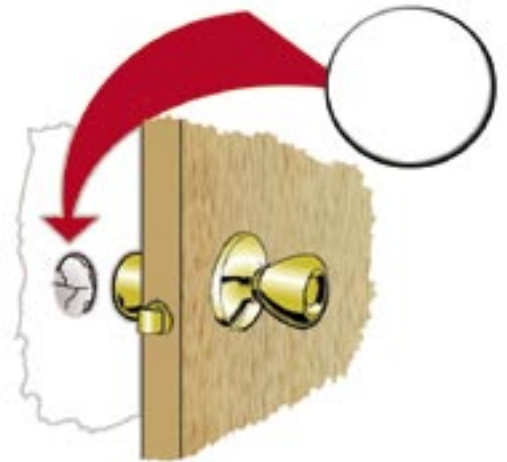

Adjustable Vinyl Door Bottom

Fills gap between the door and door bottom to prevent air, dust and water entry. Additional seal at top stops any water seepage. Pre-punched slotted holes and self-tapping screws. 36" long. 24/Ctn.

219010 White

219011 Brown

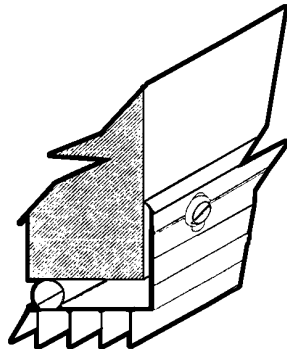

Spring-Eze Stop



Flexible brass-plated steel spring with white plastic tip. 3" long.

211004 200/Ctn.

Theft Stopper



NEW!



Allows you to easily repair damage from break-ins without replacing entire door, and protects against a reoccurrence.

Just three easy steps: remove screws from doorknob, place Theft Stopper on outside of door, then replace the knob.

212024

Roof Edge

Extra soft, heavy-gauge with standard edge. Fourteen ft. length punched with 4" centers.

265501 24/Ctn.

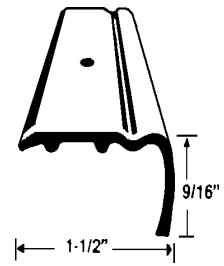

Door Viewer

One-way viewer, zinc die-cast with 180° angle plastic lens. 9/16" diameter viewer adjusts for door thicknesses 1-1/2" to 2-1/2". Installation hole is 9/16". Display boxed.

212016 Brass
212017 Chrome



Aluminum Molding Drip Rail

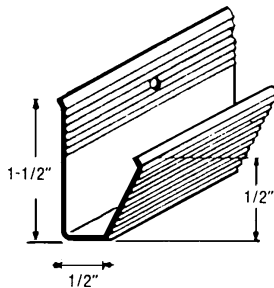

Serrated face 1-1/2" standard 1-1/2" rail 14' length w/punched 4" centers.

265503 25/Ctn.

Elixir Drip Cap

Install over doors and windows to channel away rain and snow. Steel with white finish.

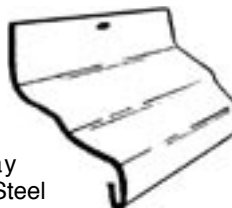

212009 For 72" door
212011 For 32" or less door
212012 For 34" door
212013 For 36" door
212014 For 48" door
212018 For 53" door

Drip Cap



Install over doors and windows to channel away rain and snow. The confined caulking area insures neat appearance and positive seal.

210950 31"
210951 35"
210953 39"
210954 43"
210955 49"

Door Sweep



1-1/2" overall width including vinyl. 37" overall length. Satin finish. Poly-bag.

219009 24/Ctn.

Elixir Threshold

Constructed of aluminum.

265506 F/32" or less door
265507 F/34" door
265508 F/36" door
265509 F/48" door
265510 F/72" door

